

## VOLTAGE REGULATION

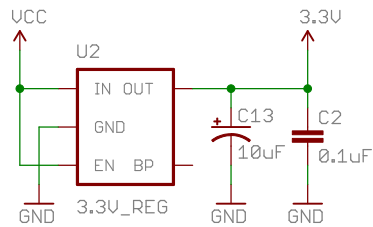

## SWITCHES & LEDS

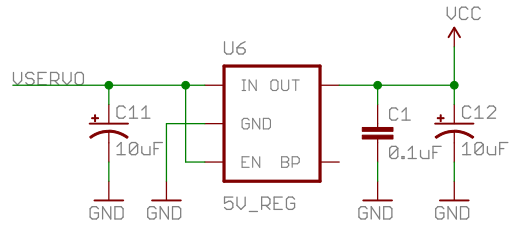
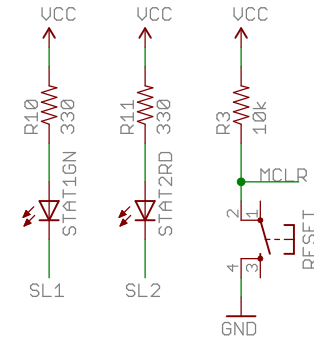
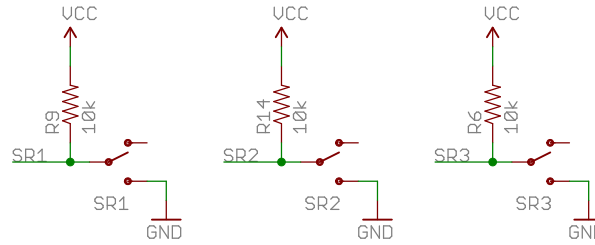

## CPU

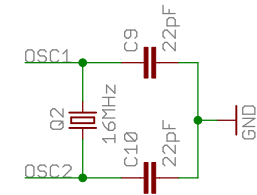
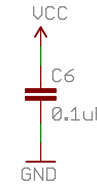
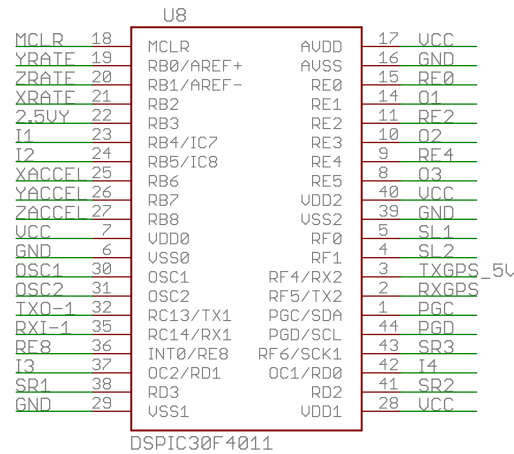

## PORTS

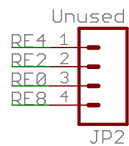
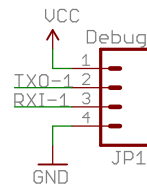
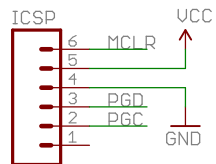

Originally Developed by  
William Premerlani, Ph.D

## UAV Development Platform

TITLE: UAV\_v23

SFE

Document Number:

REV:

Date: 10/7/2008 12:27:07 AM

Sheet: 1/2

## GYROS

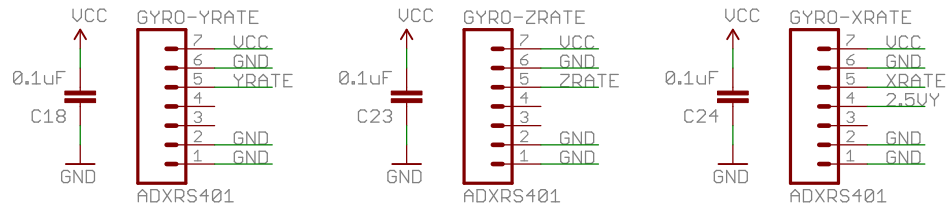

## GPS

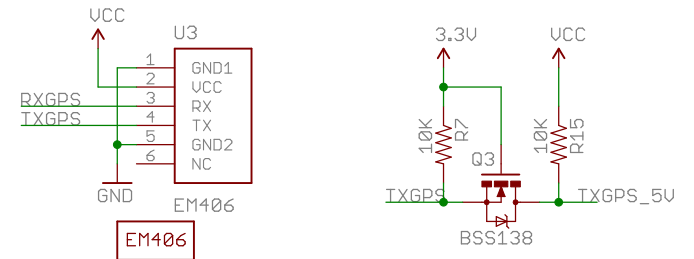

## SERVOS

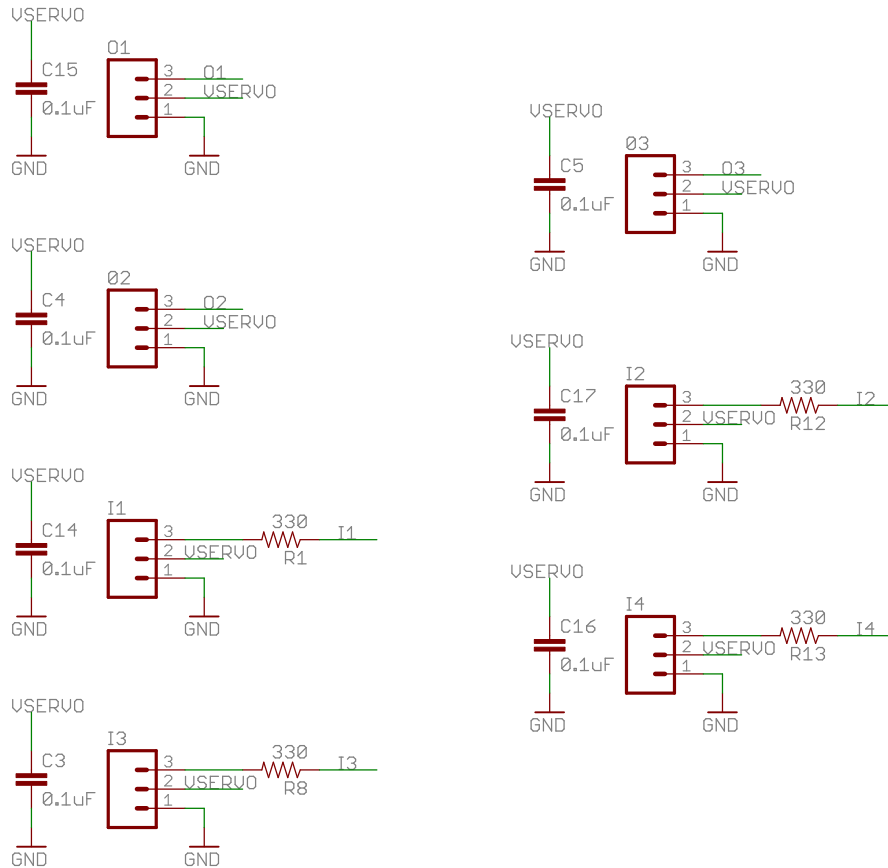

## ACCELEROMETER

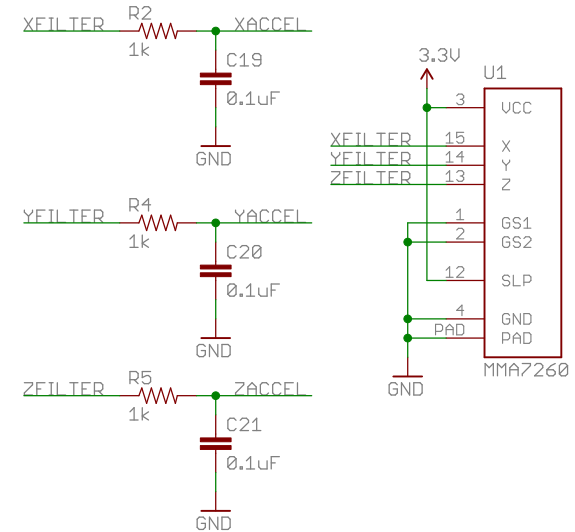

UAV Development Platform

TITLE: UAV\_v23

Document Number:

REV:

Date: 10/7/2008 12:27:07 AM

Sheet: 2/2